

USER GUIDE

SCC-DO01 Isolated Digital Output Module

The SCC-DO01 is a single-channel, optically isolated digital output module. The output circuitry consists of a photomos relay and a load resistor. You can use the SCC-DO01 with a 5–24 VDC external voltage supply to switch external devices such as transistors and solid-state relays.

Conventions

The following conventions are used in this guide:

»

The » symbol leads you through nested menu items and dialog box options to a final action. The sequence **File»Page Setup»Options** directs you to pull down the **File** menu, select the **Page Setup** item, and select **Options** from the last dialog box.



This icon denotes a caution, which advises you of precautions to take to avoid injury, data loss, or a system crash. When this symbol is marked on the product, see the *Read Me First: Safety and Radio-Frequency Interference* document, shipped with the product, for precautions to take.



This icon denotes a note, which alerts you to important information.



When symbol is marked on a product, it denotes a warning advising you to take precautions to avoid electrical shock.



When symbol is marked on a product, it denotes a component that may be hot. Touching this component may result in bodily injury.

bold

Bold text denotes items that you must select in software, such as menu items and dialog box options. Bold text also denotes parameter names.

italic

Italic text denotes variables, emphasis, a cross reference, or an introduction to a key concept. This font also denotes text that is a placeholder for a word or value that you must supply.

monospace	Text in this font denotes text or characters that you should enter from the keyboard, sections of code, programming examples, and syntax examples. This font is also used for the proper names of disk drives, paths, directories, programs, subprograms, subroutines, device names, functions, operations, variables, filenames, and extensions.
SC-2345	SC-2345 refers to both the SC-2345 connector block and the SC-2345 with configurable connectors.
SCC	SCC refers to any SCC Series signal-conditioning module.

What You Need to Get Started

To set up and use the SCC-DO01, you need the following items:

- SC-2345/2350 with one of the following:
 - SCC-PWR01
 - SCC-PWR02 and the PS01 power supply
 - SCC-PWR03 (requires a 7 to 42 VDC power supply, not included)
- One or more SCC-DO01 modules
- SC-2345/2350 User Manual*, available at ni.com
- SCC-DO01 Isolated Digital Output Module User Guide*
- SCC Quick Start Guide*, available at ni.com
- Read Me First: Safety and Radio-Frequency Interference*
- SC-2345 Quick Reference Label
- 68-pin E Series DAQ device, documentation, and 68-pin cable of less than 2 m length
- 1/8 in. flathead screwdriver
- Numbers 1 and 2 Phillips screwdrivers
- Wire insulation strippers
- NI-DAQ (current version) for Windows 2000/NT/XP/Me



Note The Macintosh operating system is not supported.

Device Specific Information



Note For general SCC module installation and signal connection information, and information about the SC-2350 carrier, refer to the *SCC Quick Start Guide*, available for download at ni.com/manuals.

Installing the Module



Caution Refer to the *Read Me First: Safety and Radio-Frequency Interference* document before removing equipment covers or connecting/disconnecting any signal wires.

Plug the SCC-DO01 into any digital input/output (P0.) socket J(X+9), where *X* is 0 to 7, on the SC-2345. When you configure the SC-2345 according to the procedure in the *SCC Quick Start Guide*, the SC-2345 routes the output signal from digital line P0.(X) on the E Series DAQ device.

Connecting Loads to the SCC-DO01



Note The signal names have changed. Refer to ni.com/info and enter `rdtntg` to confirm the signal names.

Figure 1 and Figure 2 show two ways to connect a load and an external voltage supply to the SCC-DO01. These configurations have different electrical characteristics, as described in the [Specifications](#) section.

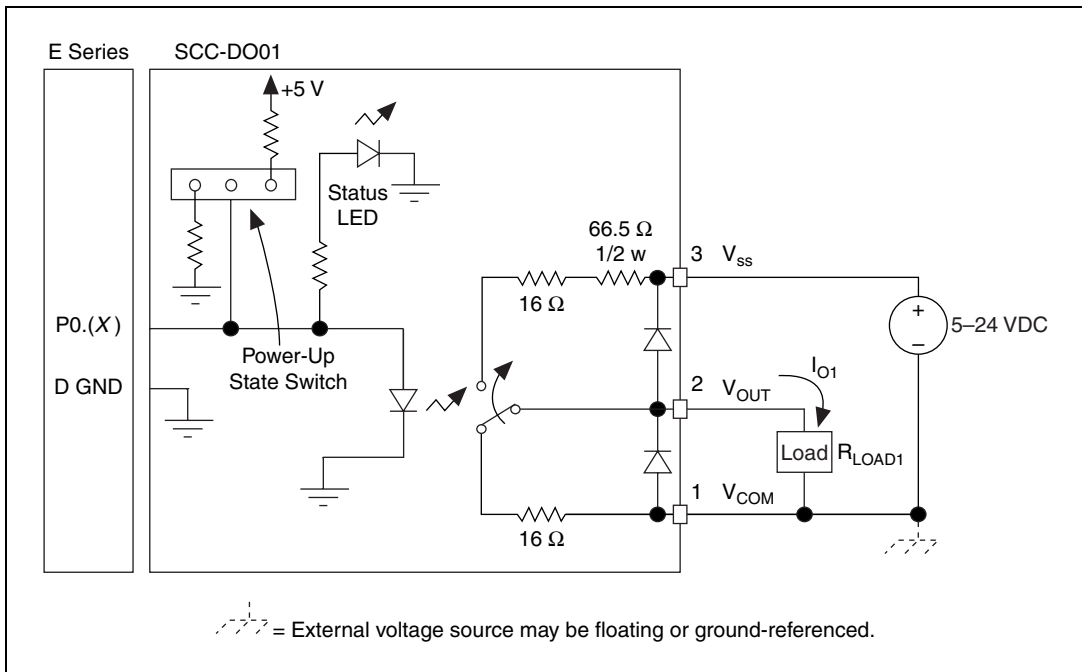

Figure 1. Connecting a Load R_{LOAD1} to V_{COM} and V_{OUT} (Configuration 1)

Figure 1 shows Configuration 1, with a load R_{LOAD1} connected to the V_{COM} and V_{OUT} terminals and a voltage supply connected to the V_{SS} and V_{COM} terminals. Connect Configuration 1 to the SCC-DO01 by completing the following steps:

1. Remove all power from the signal lines.
2. Strip 7 mm (0.27 in.) of insulation from the ends of the signal wires.
3. Insert the wires into the screw terminals.
 - a. Connect the negative lead of the voltage supply and the negative lead from R_{LOAD1} to screw terminal 1, V_{COM} .
 - b. Connect the positive lead from R_{LOAD1} to screw terminal 2, V_{OUT} .
 - c. Connect the positive lead of the voltage supply to screw terminal 3, V_{SS} .
4. Tighten the screws to 0.5 to 0.6 N · m (4.4 to 5.3 lb · in.) of torque.

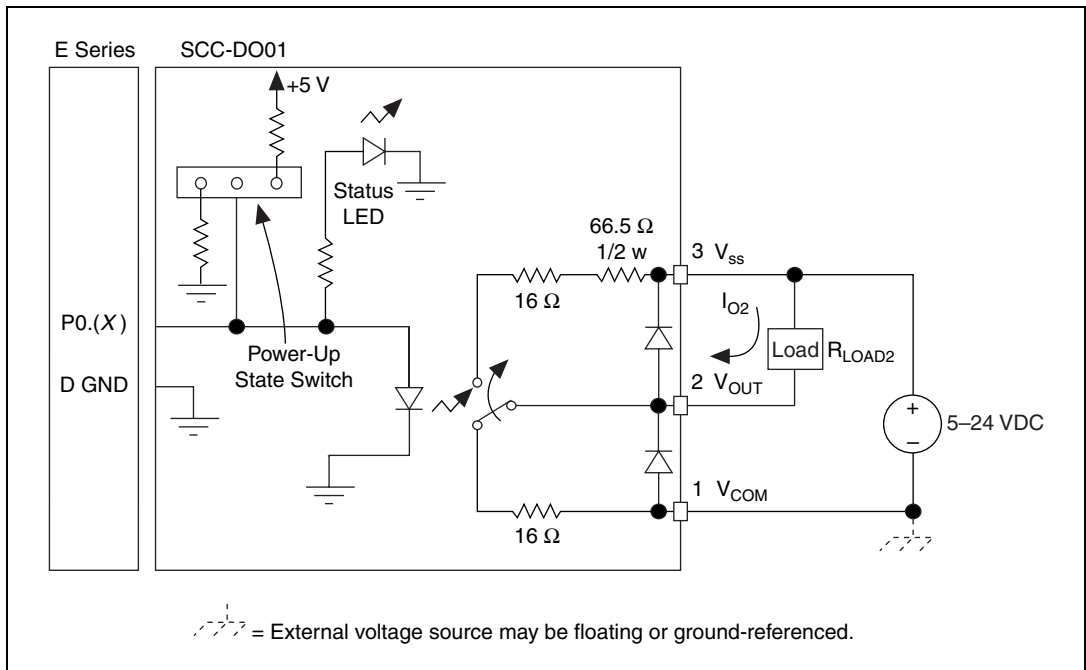

Figure 2. Connecting a Load R_{LOAD2} to V_{OUT} and V_{SS} (Configuration 2)

Figure 2 shows Configuration 2, with a load R_{LOAD2} connected to the V_{OUT} and V_{SS} terminals and a voltage supply connected to the V_{COM} and V_{SS} terminals. Connect Configuration 2 to the SCC-DO01 by completing the following steps:

1. Remove all power from the signal lines.
2. Strip 7 mm (0.27 in.) of insulation from the ends of the signal wires.
3. Insert the wires into the screw terminals.
 - a. Connect the negative lead of the voltage supply to screw terminal 1, V_{COM} .
 - b. Connect the negative lead from R_{LOAD2} to screw terminal 2, V_{OUT} .
 - c. Connect the positive lead of the voltage supply and the positive lead from R_{LOAD2} to screw terminal 1, V_{SS} .
4. Tighten the screws to 0.5 to 0.6 N · m (4.4 to 5.3 lb · in.) of torque.

For information about configuring the SCC-DO01 module using NI-DAQmx, refer to the *SCC Quick Start Guide*.

Specifications

These specifications are typical at 25 °C unless otherwise stated.

Output Characteristics

CompatibilityTTL-compatible

Number of channels 1

Supply voltage range5 to 24 VDC

Digital logic levels

Configuration 1 (refer to Figure 1)

Logic Level	Output Voltage Level between V_{OUT} and V_{COM}
Low ($I_{O1} = 0$ mA)	0 V
High ($I_{O1} = 25$ mA)	22 VDC at $V_{SS} = 24$ V 3 VDC at $V_{SS} = 5$ V

Configuration 2 (refer to Figure 2)

Logic Level	Output Voltage Level between V_{OUT} and V_{COM}
Low ($I_{O2} = 25$ mA)	0.4 V
High ($I_{O2} = 0$ mA)	V_{SS}

Maximum continuous load current (I_O)

Configuration 186 mA

Configuration 2120 mA

Minimum load resistance (at $V_{SS} = 24$ V)

R_{LOAD1} 196 Ω

R_{LOAD2} 184 Ω

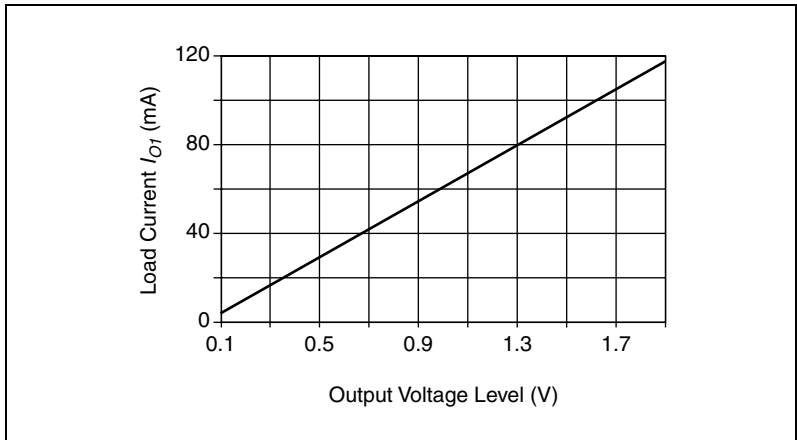

Figure 3. Load Current versus Output Voltage, Configuration 1

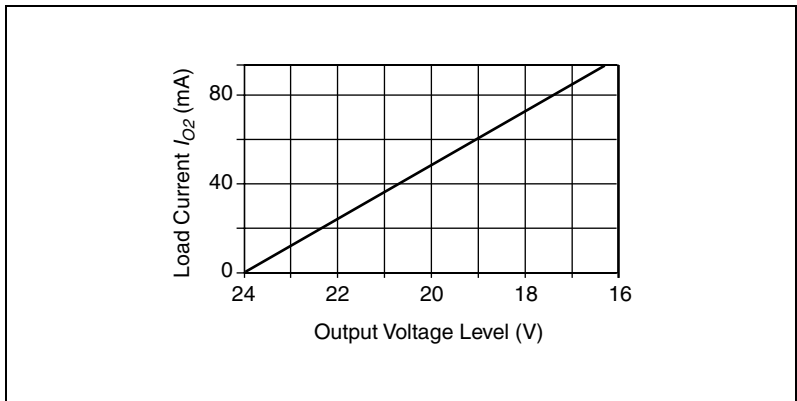

Figure 4. Load Current versus Output Voltage, Configuration 2

Propagation delay

Low to high 400 μ s typ¹

High to low 300 μ s typ¹

Rise time 120 μ s typ

Fall time 25 μ s typ

¹ The switching characteristics (turn-on time, switching time, and turn-off time) of the optical isolator used on the board limit the data transfer rate.

Power Requirement

Digital power69 mW max

Physical Characteristics

Dimensions8.89 cm × 2.92 cm × 1.85 cm
(3.50 in. × 1.15 in. × 0.73 in.)

Mass28.6 g (1.0 oz)

I/O connectors.....One 20-pin right-angle
male connector;
one 2-pin screw terminal

Field-wiring diameter28 to 16 AWG

Maximum Working Voltage

Maximum working voltage refers to the signal voltage plus the common-mode voltage.

Channel to earth42 V, Installation Category 2

Module to module42 V, Installation Category 2

Environmental

Operating temperature0 to 50 °C

Storage temperature–20 to 70 °C

Humidity10 to 90% RH, noncondensing

Maximum altitude2,000 m

Pollution Degree (indoor use only)2

Safety

The SCC-DO01 meets the requirements of the following standards for safety and electrical equipment for measurement, control, and laboratory use:

- IEC 61010-1, EN 61010-15
- UL 3111-1, UL 6101B-1
- CAN/CSA C22.2 No. 1010.1



Note For UL and other safety certifications, refer to the product label, or visit ni.com/hardref.nsf, search by the model number or product line, and click the appropriate link in the Certification column.

Electromagnetic Compatibility

Emissions EN 55011 Class A at 10 m
FCC Part 15A above 1 GHz

Immunity EN 61326:1997 + A2:2001,
Table 1

CE, C-Tick, and FCC Part 15 (Class A) Compliant



Note For full EMC compliance, operate this device with shielded cabling. In addition, all covers and filler panels must be installed.

CE Compliance

This product meets the essential requirements of applicable European Directives, as amended for CE marking, as follows:

Low-Voltage Directive (safety) 73/23/EEC

Electromagnetic Compatibility
Directive (EMC) 89/336/EEC



Note Refer to the Declaration of Conformity (DoC) for this product for any additional regulatory compliance information. To obtain the DoC for this product, visit ni.com/hardref.nsf, search by model number or product line, and click the appropriate link in the Certification column.

Figure 5 shows the I/O connector on the bottom of the SCC-DO01.

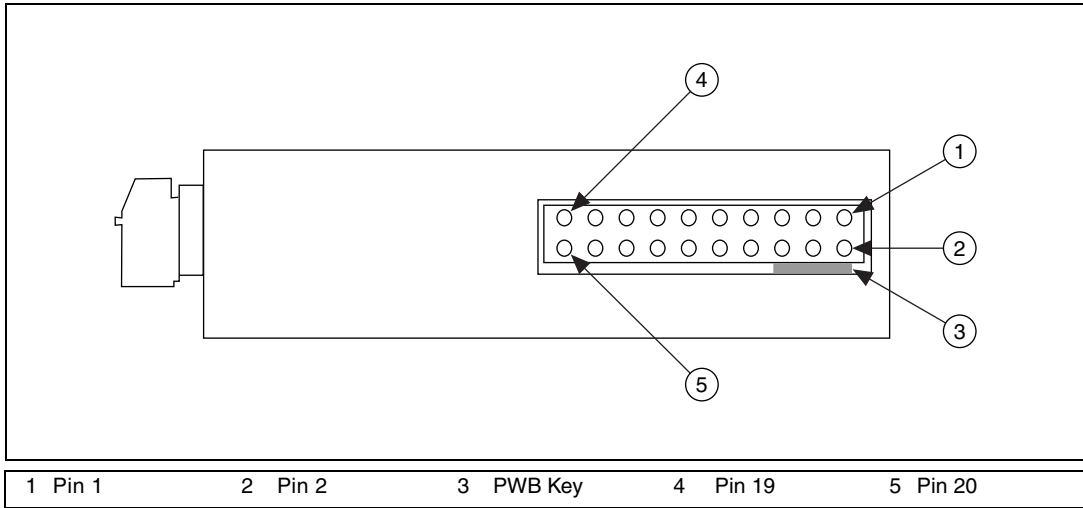

Figure 5. SCC Module Bottom View

Table 1 lists the signal connection corresponding to each pin. GND is the reference for the +5 V supply.

Table 1. SCC-DO01 Pin Signal Connections

Pin Number	Signal
1	—
2	—
3	—
4	—
5	—
6	—
7	P0.(X)
8	—
9	+5 V
10	GND
11	—
12	—
13	—

Table 1. SCC-DO01 Pin Signal Connections (Continued)

Pin Number	Signal
14	—
15	—
16	—
17	—
18	—
19	—
20	—

Theory of Operation

Setting the Power-Up State of the SCC-DO01

The switch for setting the power-up state of the SCC-DO01 is on the top of the module. Switch it to *High* or *Low* depending on whether you want the output state to be high or low on power-up. The switch does not override the output state as determined by the E Series DAQ device.

Status LED

The SCC-DO01 has a status LED that indicates when an input signal registers a logic high or a logic low. The LED is located above the screw terminals. If the LED is off, the input signal is registering a logic low on the digital line.

Circuit Protection

Protection Against Spike Voltages

Two clamping diodes protect the SCC-DO01 against spike voltages caused by inductive loads and long circuit wires. One diode is connected across V_{SS} and V_{OUT} and the other diode is connected across V_{OUT} and V_{COM} .

Signal Isolation

The V_{COM} , V_{SS} , and V_{OUT} signals on each SCC-DO01 are isolated from other channels and from the SCC-DO01 internal power and ground signals. The isolation barrier protects the SCC-DO01 and other equipment from voltages up to +42 VDC. Common-mode voltages higher than +42 VDC can damage the SCC-DO01 and other equipment.

